

Joh 15:18 b

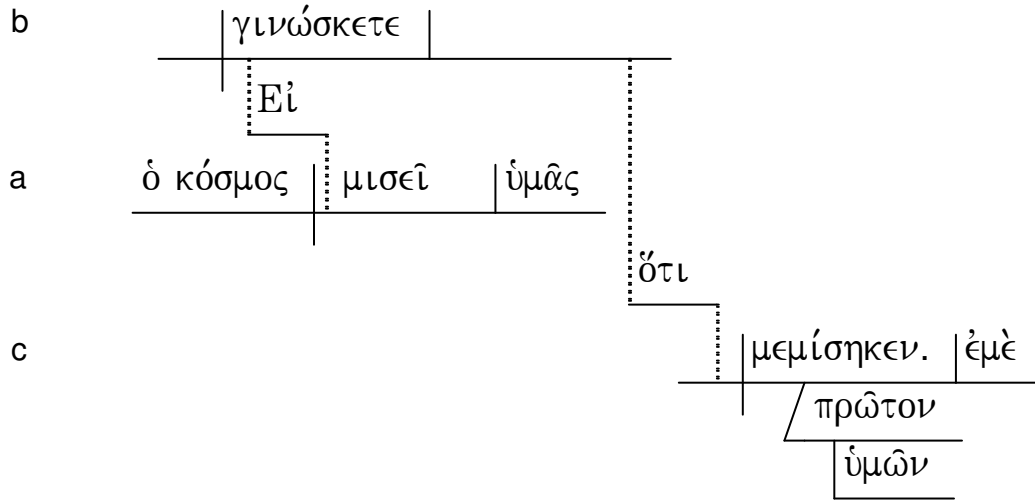

Joh 15:19 b

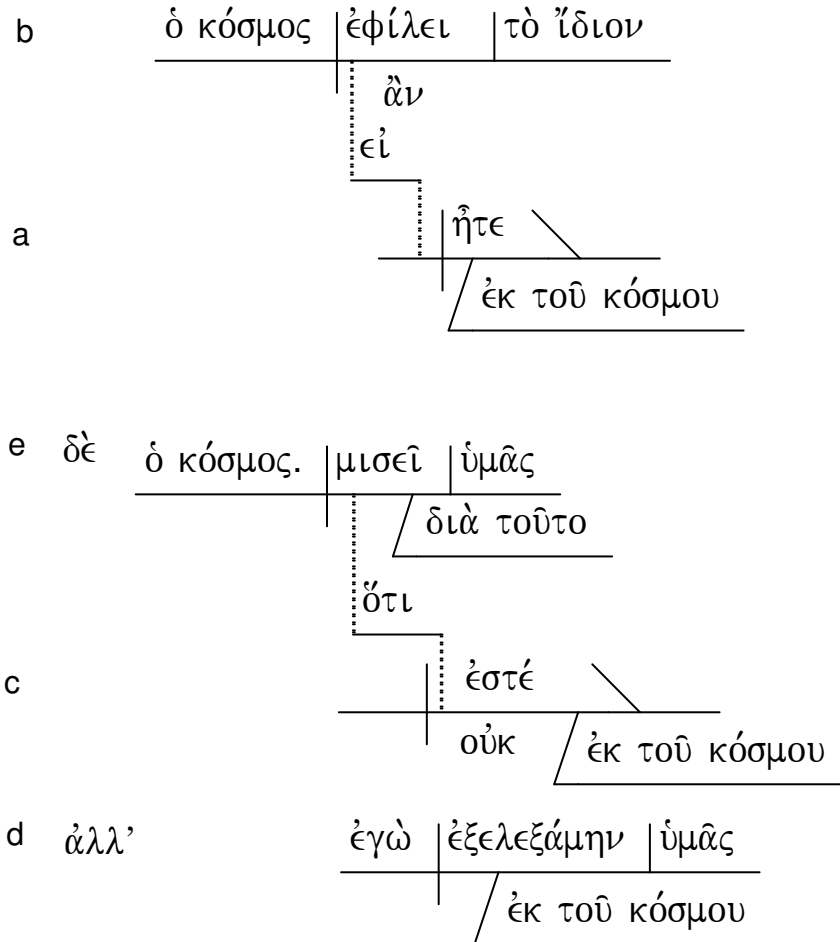

Joh 15:20 a

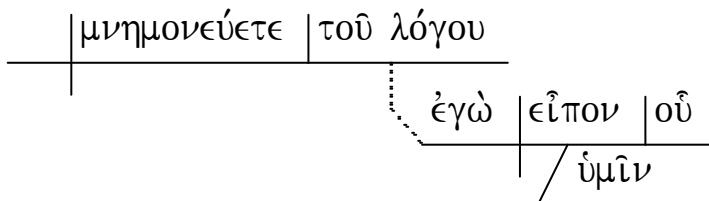

b

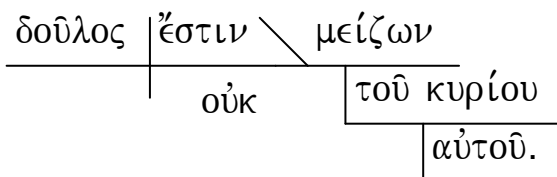

d

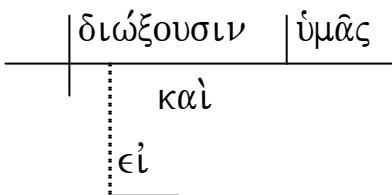

c

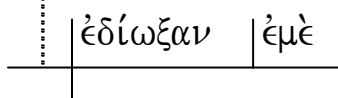

f

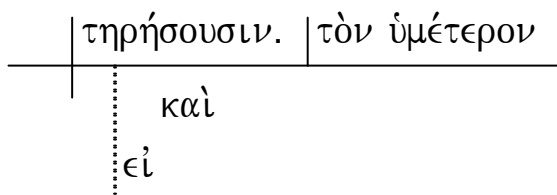

e

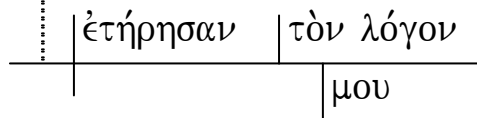

Joh 15:21 a

ἀλλὰ

Contrary to expectations,  
see Runge pp. 55-56

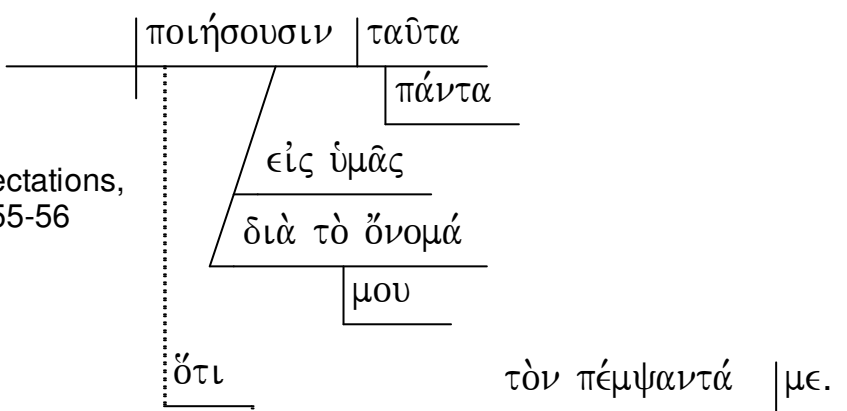

b

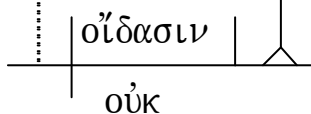

Joh 15:22 c

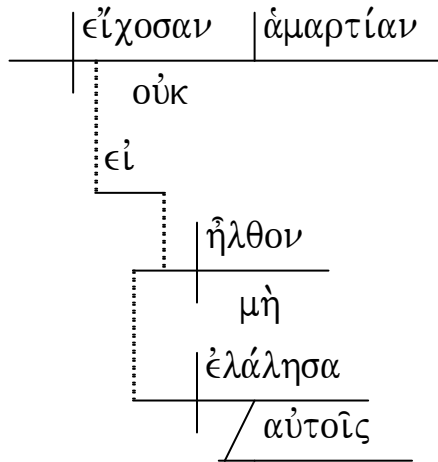

a

b

d δὲ

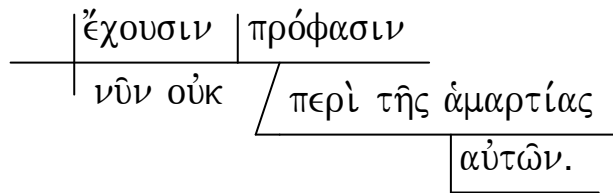

Joh 15:23

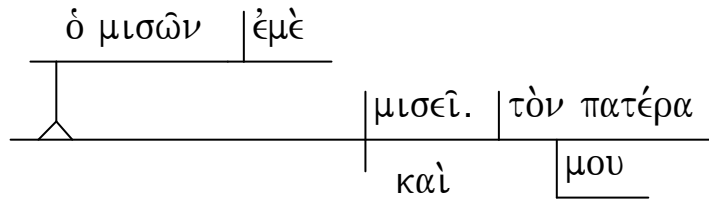

Joh 15:24 b

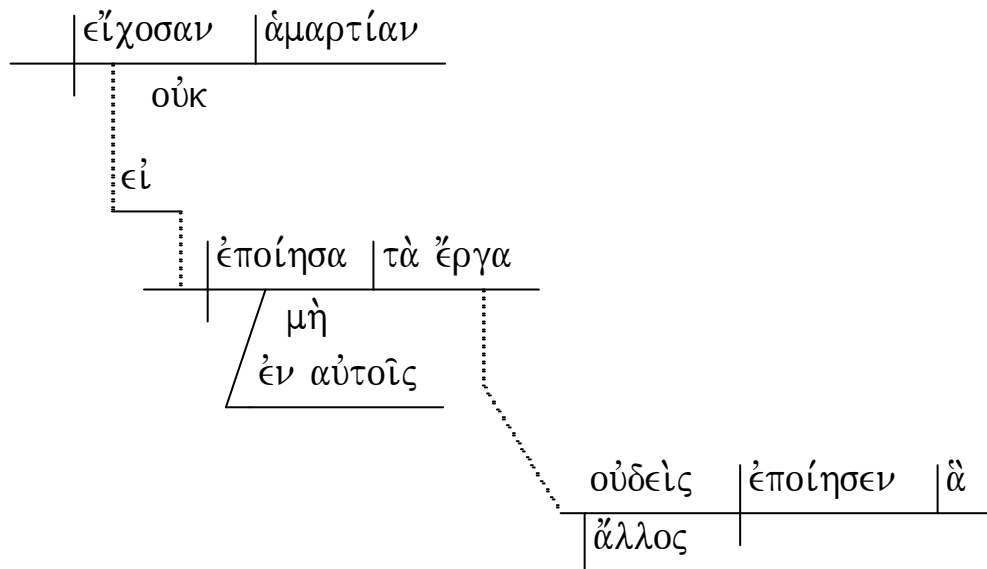

a

c δὲ καὶ

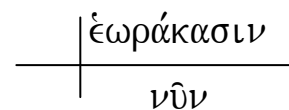

d καὶ

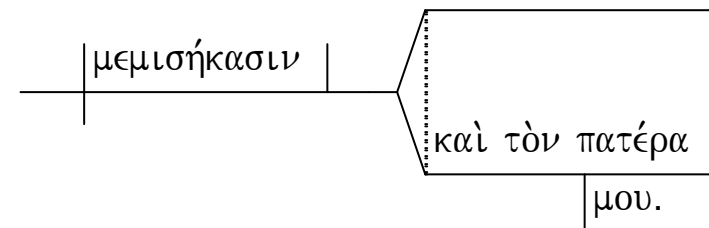

**Joh 15:25** a ἀλλ’

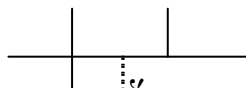

ἵνα

b

ὁ λόγος πληρωθῆ



c

ὁ γεγραμμένος

ἐν τῷ νόμῳ

αὐτῶν

ὅτι

d

ἐμίσησάν με

δωρεάν.